

## Technology

### Angle Bracket Pack



#### Item code: Ta1

- Each pack contains 10 brackets, 75mm long with 5 holes per length
- They can be cut to size and used to fix components at right angle to each other

### Anvil - Coco Pan

#### Item code: Ta2

- 150mm long rail - coco pan

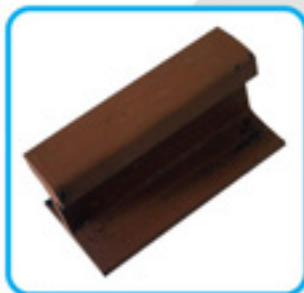

### Balloon

#### Item code: Tb1

- Can be used in pneumatics projects to create movement

### Battery

#### Item code: Tb2

- Central positive head
- For use with cell holder or snap
- A) Small rectangular 9V
- B) AA (penlight) size, 1.5V
- C) D size, Torch type 1.5V



## Technology

### Battery Cell Holder



#### Item code: Tb3

- Strong plastic tray type
- Tension screw on one end
- Terminal screw on the other
- Takes 4 D-type cells
- Can use 1, 2, 3 or 4 cells in series

### Battery Charger

#### Item code: Tb4

A) Dual type for 6 and 12V

- 5A fuse
- Also available 12V 8A fuse

B) Trickle type

- 6V/12V



### Battery Charger - 12v: Trickle

#### Item code: Tb5

- For lead acid batteries

### Battery Holder

#### Item code: Tb6

A) To take 1 AA cell (with connecting wires)

B) To take 2 AA cells (excluding snap)

C) To take 4 AA cells (excluding snap)



## Technology

### Battery - Lead Acid: Sealed



- Item code: Tb7**  
 · Rechargeable, 6V 4.2A

### Battery - Rectangular: 9v-Pm9

- Item code: Tb8**  
 · Use for long life



### Battery Snap/Stud

- Item code: Tb9**  
 · To fit battery holders Tb6

### Bench Hook

- Item code: Tb10**
- Made from plastic
  - Used to secure timber when sawing with tenon saw
  - With adjustable cam
  - Size: 150 x 120mm



## Technology

### Bradawl



**Item code: Tb11**

- For making holes in wood, card and plastic
- Sharp tipped metal shaft in PVC handle

### Brush

**Item code: Tb12**

- For painting or pasting and varnishing
- Available in the following widths: 13mm, 19mm, 25mm, 50mm, 75mm
- Also available in set of 4 (19, 25, 38, 50mm)



### Brush - Flat: Art

**Item code: Tb13**

- Ideal for watercolour work
- Sizes available: Ref 1, Ref 6, Ref 12, 10-12mm, Ref 18

### Buzzer - Piezo Type

**Item code: Tb14**

- Simple type with wire

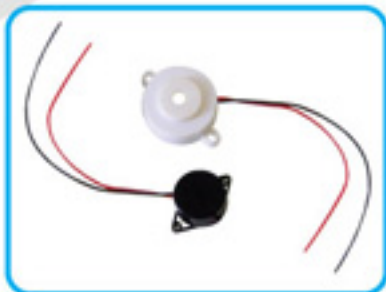

## Technology

### Calliper - Vernier

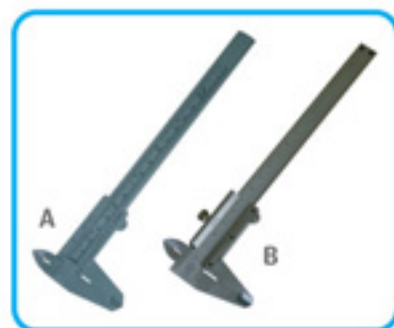

#### Item code: Tc1

- A) Plastic
- Direct reading
  - Dual scale
  - 0 - 150mm
- B) Stainless steel
- Direct reading
  - 0 - 150 x 0,1mm

### Cam Pack

#### Item code: Tc2

- The pack contains 10 each of 2 different size pear-shaped cams with 4mm axle holes

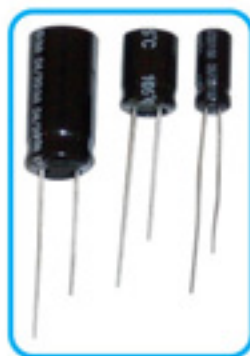

### Capacitor

#### Item code: Tc3

- 10mf 25V
- 100mf 25V
- 1000mf 25V

### Cardboard - Corrugated

#### Item code: Tc4

- Rigid 600 x 450, packet of 10
- Flexible 10 x 1200mm roll



# Technology

## Cardboard Sheet



### Item code: Tc5

- Suitable for modelling projects
- Size 600 x 450 x 1mm
- Packet of 10

## Cardboard - Triangle Pack

### Item code: Tc6

- Pack: 10 x A4 sheets
- Cardboard triangles
- Can be used to reinforce and make strong joints when joining wood strips

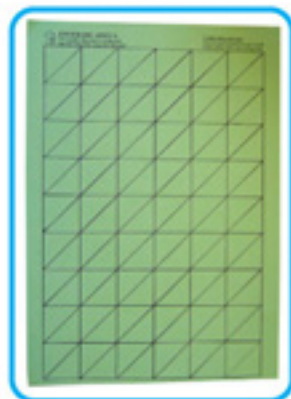

## Chart - Wall

### Item code: Tc7

- A1 size
- Technology
- Set of 20

## Clamp - G

### Item code: Tc8

- For holding wood steady during work or while glue dries
- Available in the following sizes: 50mm, 75mm, 100mm, 150mm



## Technology

### Clip - Crocodile



#### Item code: Tc9

- To make up wire leads
- Red
- Black

### Connector - T

#### Item code: Tc10

- 3 Way (T)
- 3mm OD
- Ideal for pneumatics and hydraulics
- Used with 3mm PVC tubing



### Cotton Reel

#### Item code: Tc11

- Plain plastic reels
- Ideal for building models

### Crimping Tool

#### Item code: Tc12

- Crimp insulated terminals 1 - 6mm
- Strips and cuts wire





## Technology

### Cup & Spoon Measuring Set



**Item code: Tc13**

- Measuring set
- For food technology

### Cutter - Hot Wire: Table Model

**Item code: Tc14**

- Suitable for cutting shapes and designs from polystyrene material
- Very low cost table model with large 500 x 500mm top working surface
- Allows both hands free to guide the material through the cutter
- Can cut sheets up to 150mm thick and 1m wide
- Thermostat control to regulate temperature of the cutting wire for neat, clean cuts
- Simple and easy to use



### Cutter - Plastic

**Item code: Tc15**

- For cutting of rigid plastic rod 4 - 5mm
- Cuts rod at 45°, 60° or 90°



## Technology

### Cutting Mat

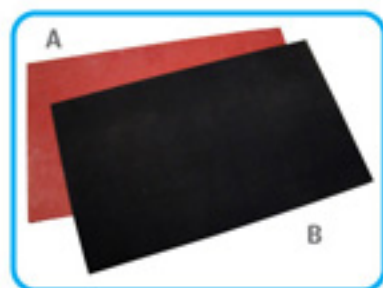

#### Item code: Tc16

- Rubber surface
- Sizes:
  - A) 500 x 300 x 3mm
  - B) 500 x 300 x 10mm

### Diode Rectifier

#### Item code: Td1

- 1N4007
- Packet of 10

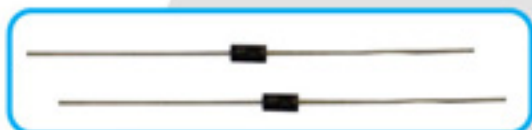

### Drawing Board

#### Item code: Td2

- Complete with T-square
- In carrying pouch
- A3

### Drill Bit

#### Item code: Td3

- For wood, metal, plastic and perspex drilling
- Set of 13 pieces
- Also available in individual sizes



## Technology

### Drill - Hand



#### Item code: Td4

- Manual
- With 6mm chuck
- Double pinion
- Enamel finish with hardwood or plastic handle

### Drill - Hand: Pistol Grip

#### Item code: Td5

- Manual
- Enclosed type with 6mm chuck
- High gear ratio/easy turn
- Ideal for young children



### Drill - Paper

#### Item code: Td6

- A simple tool for making holes in paper or card
- Cuts  $\pm 3 - 6$ mm

### Elastic Band

#### Item code: Te1

- Ideal for binding or as driving pulley
- 100gm box



## Technology

### Electronic Kit - Basic



#### Item code: Te2

- Ideally suitable for any person who shows an interest, but has no previous experience in electronics
- Learners from a Senior Primary level through to students at Tertiary level will gain a better understanding of electronics
- Complete with book detailing 57 different investigations
- This kit consists of the following:

- 1) Basic voltage sources
- 2) Series and parallel circuits
- 3) Voltage divider
- 4) Thermistor
- 5) Light dependent resistor

- 6) Diode circuits
- 7) Bias voltage of a diode
- 8) Light emitting diode
- 9) Zener diode
- 10) Transistor circuits

- 11) Alarm circuits
- 12) Capacitor circuits
- 13) Multivibrator circuits
- 14) Amplifier circuits
- 15) Basic logic circuits

### Extension Lead

#### Item code: Te3

- Extension with male and double female plugs
- 5m x 16A
- 10m x 16A



### Fasteners - Paper

#### Item code: Tf1

- With round head and split legs
- 25mm long
- Packet of 100
- Ideal for using as pivot joints in linkages

## Technology

### Files - Wood



#### Item code: Tf2

- For shaping wood, soapstone and soft materials
- 3 types: round, half-round and flat
- With wooden or plastic handles

### First Aid Kit

#### Item code: Tf3

- Variations:
  - Plastic box with lid
  - Vinyl pouch
  - Training kit complete with manual (suitable for larger groups)
- Consists of:
  - 1) 1 x Eye cup
  - 2) 1 x Roll bandage 75, 50mm
  - 3) 1 x Triangular bandage
  - 4) 10 x Pain tablets
  - 5) 10 x Plasters
  - 6) 30ml Antiseptic liquid
  - 7) 30gm Antiseptic cream
  - 8) 5ml Eye drops
  - 9) 1 pair latex gloves
  - 10) 1 pair scissors
  - 11) 1 pad cotton wool
  - 12) 1 x Resusi-aid
- Also available: First Aid Training Kit (see Kf2)



### Gear Pack

#### Item code: Tg1

- Contains 10 each of 15, 30, 45 and 75 toothed gears, the diameters being 17, 32, 47 and 76mm respectively
- Gears can lock into each other when creating a gearbox
- Each pack contains 10 locking bushes to fix the gears firmly to an axle

## Technology

### Gear - Specialised Pack



#### Item code: Tg2

- Pack contains 10 worm, 10 crown, 10 bevel and 10 rack gears
- All mesh perfectly with the normal gears

### Glue - Contact

#### Item code: Tg3

- Multipurpose glue
- 50gm tube



### Glue Gun - Electric

#### Item code: Tg4

- Safely bond
- Ideal for thermally sensitive material, polystyrene, synthetic fabrics etc
- A) Mini glue gun: 10W
- B) Large glue gun: 60W

### Glue Stick

#### Item code: Tg5

- For use with electric glue gun
- A) Mini
  - 8 x 100mm
  - Packet of 12
- B) Large
  - 11.2 x 300mm
  - Packet of 32 (1kg)



## Technology

### Glue - Wood & Paper



**Item code: Tg6**

- Quick setting
- A) 125ml PVC bottle with spout
- B) 500ml PVC bottle with spout

### Goggle - Safety

**Item code: Tg7**

- Helps avoid chemical or dust contact with eyes or splinting contact with eyes
- A) Plastic - with elastic strap
- B) Spectacle - with side shield



### Hacksaw - Junior

**Item code: Th1**

- Sturdy design
- Tensioning frame
- With vertical handle, 150mm long
- Spare blades (junior) available in packet of 10

### Hacksaw - Tubular

**Item code: Th2**

- Economical
- Light weight
- General purpose
- Adjustable for 250 x 300mm blades



## Technology

### Hammer - Ballpeen



**Item code: Th3**

- Standard pattern ball and quality wooden handles
- 110gm or 200gm

### Hammer - Claw

**Item code: Th4**

- Can pull out nails
- A must for woodworking activities
- A) 250gm wooden handle (Junior)
- B) 550gm fibre handle (Senior)



### Hammer - Pin (Telephone)

**Item code: Th5**

- Ideal tool for children

### Hole Saw

**Item code: Th6**

- Heavy duty for cutting wood, plywood and soft grade metal
- 7 Blades 50mm deep, 25 - 63mm  $\phi$
- With 6mm shank pilot drill bit





## Technology

### Ice Cream Stick



#### Item code: Ti1

- Wooden
- Box of 100
- A) 18 x 140mm
- B) 10 x 110mm

### Knife - Trimming

#### Item code: Tk1

- Retractable blade
- Sharp, new segments with new edge
- Spare blades available in packs of 10
- A) 8 point snap-off, high quality type
- B) 8 point snap-off, economy type



### Knife - Utility

#### Item code: Tk2

- Suitable for cutting plastic and cardboard
- Either with a fixed blade or retractable blade



### Lamp for Lampholder

#### Item code: TI1

- Screw thread
- Available options:  
1.5V - 0.3A, 2.5V - 0.3A, 3V - 0.3A,  
3.8V - 0.3A, 4.9V - 0.3A, 6V - 0.5A



## Technology

### Lampholder



#### Item code: T12

- Takes flashlight bulbs
- Rolled shell of plate brass
- Moulded plastic base
- 2 Screw connections
- Fixing hole centres 22mm
- Base: 30mm
- Height: 22mm

### Lampholder

#### Item code: T13

- Economy type
- MES for screw cap lamps
- With 2 soldered ends



### LED

#### Item code: T14

- These alternative to lamps add colour to your item
- Red, orange, green and white available

### Light Dependent Resistor

#### Item code: T15

- For control systems



## Technology

### Line Bender



#### Item code: Tl6

- Low cost table model with 350mm length wire heating element
- Perfect for bending shapes and articles from sheet plastic
- Learners can shape a whole range of projects using this machine
- The unit has a temperature setting dial to control the heating effect of the wire element

### Magnifier - Helping Hand

#### Item code: Tm1

- With magnifying glass
- Solder (crocodile) clamps



### Micrometer

#### Item code: Tm2

- Screw gauge
- Made with hardened and ground screw
- Thimble with ratchet
- Lever lock to spindle
- Frame fitted with heat-insulating cover
- Satin chrome overall
- Range 0 - 25 x 0.01mm precision



### Mitre Box

#### Item code: Tm3

- Plastic saw guide for accurate cutting of mitre joints
- Wire tennon (back) saw



## Technology

### Motor



#### Item code: Tm4

- Available in:
  - Economy type: 1.5 - 3V
  - Medium torque type: 3 - 4.5V
  - High torque type: 4.5 - 6V

### Motor Gear/Pulley Pack

#### Item code: Tm5

- Gear and pulley on same shaft
- Push fit with 2mm centre hole that fits Tm4 motors
- Gear: 10 tooth, meshes with standard gear pack
- Pack of 10



### Motor Kit

#### Item code: Tm6

- Can be used to motorise projects that learners have built with the Technology class starter pack
- Consists of:
  - 1) 10 x Electric motors
  - 2) 10 x Gears/pulleys to fit motor
  - 3) 10 x Motor mounting bracket
  - 4) 10 x SPDT mini toggle switches
  - 5) 10 x Battery holders 2 AA with battery snap
  - 6) 5m Red and black leads

### Multimeter

#### Item code: Tm7

- Multirange
  - Range selection by single control knob
  - Black pointer
  - Instructions
  - Test leads
  - Probes
  - Battery
- 10A, 10A - 5 ranges
  - 0.1V, 1kV - 9 ranges
  - 10A - 1 range
  - 10V, 1kV - 5 ranges
  - x1, x100, 10k
  - 20k/V



## Technology

### Nut & Bolt Pack



#### Item code: Tn1

- These nuts and bolts are ideal for joining the different plastic components to each other and to other materials e.g. wood strips
- Packet of 100
- Each pack contains:
  - 1) 100 4mm galvanized bolts - 12, 16, 20, 25 or 50mm long
  - 2) 100 M4 nuts
  - 3) 100 M4 washers

### Paint - Powder

#### Item code: Tp1

- Available in various colours
- A) 500gm
- B) Packet of 6 x 75gm



### Palette Knife

#### Item code: Tp2

- Stainless steel
- Parallel side blade
- Balanced wooden handle
- 100mm/150mm/200mm/250mm/300mm



### Panel Pin

#### Item code: Tp3

- For joining wood strips
- 30mm long
- 500gm

## Technology

### Perforated Plate Pack

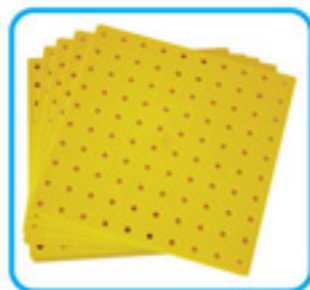

#### Item code: Tp4

- The pack contains 10 plates each 150 x 150mm
- These can be cut to the desired size or cut in halves or quarters
- The plates make an ideal base for mounting gears and pulleys or in constructions
- 4mm holes at 15mm intervals

### Perspex Sheet

#### Item code: Tp5

- Clear 1830 x 1220 x 2mm
- Other colours and thicknesses on request



### Pin - Drawing

#### Item code: Tp6

- Ideal for pressing down of objects
- Box of 100

### Plasticine Clay

#### Item code: Tp7

- Ideal for use in small models
- 500gm pack





## Technology

### Pliers

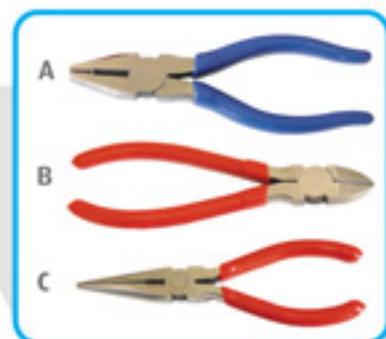

#### Item code: Tp8

- Also available: 115mm mini side cutter for electronics
- A) 150mm combination pliers
- B) 150mm diagonal cutting pliers
- C) 150mm long nose pliers

### Pliers - Leather Punch

#### Item code: Tp9

- Ideal for making different size holes in leather or cardboard
- With revolving head
- 6 Standard punch tubes: 2, 2.5, 2.8, 3.2, 4.0 and 4.8mm  $\varnothing$

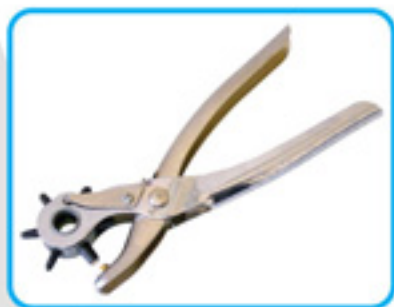

### Pliers - Raco Eyelet

#### Item code: Tp10

- Ideal for making a reinforced hole
- 150mm long, all metal construction
- Complete with 100 eyelets

### Plug

#### Item code: Tp11

- 15A, 3 Pin
- To fit to standard electrical items





## Technology

### Pneumatics & Hydraulics Kit



#### Item code: Tp12

- Ideal for pneumatics and hydraulic projects
- Consists of:
  - 1) 2 x 10ml plastic syringes
  - 2) 2 x 20ml plastic syringes
  - 3) 1 x 50ml plastic syringes
  - 4) 1m PVC tubing 3mm
  - 5) 2 x T-pieces 3mm od

### Pop Riveter

#### Item code: Tp13

- Hand type
- One hand operation with 4 hardened screws in nozzles for 2.4
- 4.8mm rivets



### Power Supply Ep125

#### Item code: Tp14

- Clear voltage selector switch
- Lockable switch
- Smooth/unsmoothed DC output and AC output
- Overload protection
- 1 - 12V at 5A continuous in 1V steps
- Cost effective
- Conforms to CE specifications

### Project Board

#### Item code: Tp15

- A4
- Packet of 100
- Various colours



## Technology

### Pulley Pack

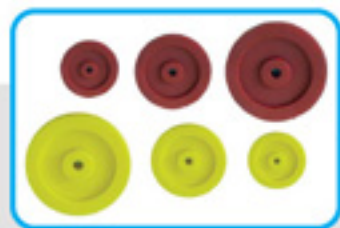

#### Item code: Tp16

- Contains 10 each of pulleys with diameters of 30, 38 and 48mm
- Rubber bands, string or our elastic pulley belt can be used as pulley drives

### Punch - Paper

#### Item code: Tp17

- Single 6mm hole pliers
- Used to make holes in paper and cardboard



### Reamer Drill

#### Item code: Tr1

- To enlarge holes in wood, plastics and cardboard
- 4.2mm drill type on handle
- For reaming 4mm holes

### Resistor

#### Item code: Tr2

- Ideal for small circuits
- 390 ohm, 470 ohm, 680 ohm, 1k ohm, 10k ohm



## Technology

### Rod - Plastic



**Item code: Tr3**

- To construct various structures and projects
- Rod supplied in 450mm lengths of 4 and 5mm  $\phi$
- 8mm rod is also available that is suitable for wheel spacers

### Ruler - Safety

**Item code: Tr4**

- Stainless steel
- 300mm long
- With curved profile for protection of fingers when craft knife is used



### Ruler - Stainless Steel

**Item code: Tr5**

- 300mm long
- Engineer's type
- Used for accurate measurements and for cutting

### Sand Paper Block - Rubber

**Item code: Ts1**

- For ease of working
- Sandpaper can easily be fitted



## Technology

### Sand Paper - Square



**Item code: Ts2**

- Various grits
- A4
- Packet of 10

### Saw - Coping

**Item code: Ts3**

- For use where slight curves are required
- For cutting of thin material
- Spare blades available

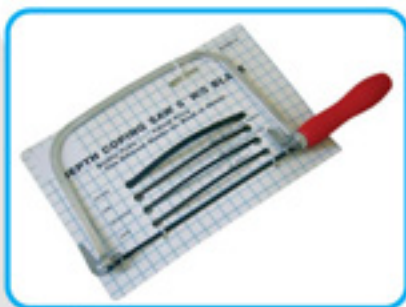

### Saw - Crosscut

**Item code: Ts4**

- Cross-cut for cutting across the grain
- 500mm long
- Wooden handle
- For general wood cutting

### Saw - Fret

**Item code: Ts5**

- For light machine sawing
- Cuts curves and irregular shapes in thin wood
- Spare blades available



## Technology

### Saw - Tennon



#### Item code: Ts6

- Makes cutting easy
- Teeth precision cut and set
- Styled for comfort and ease of handling
- 300mm (Backsaw)

### Scale - Kitchen

#### Item code: Ts7

- With plastic bucket
- Dial indicator
- 500gm, 2kg and 5kg capacity



### Scissor

#### Item code: Ts8

- Closed shanks
- Straight, blunt/sharp
- Stainless steel
- 125mm
- 160mm
- Also available in 150mm blunt type



### Scissor - Junior

#### Item code: Ts9

- 132mm blunt ends



## Technology

### Scissor - Office



**Item code: Ts10**

- Stainless steel with plastic handles
- Ideal for everyday use
- Cuts most materials
- 180mm long

### Scissor - Raco

**Item code: Ts11**

- Hardened stainless steel blades
- Suitable for cutting tin, brass, copper, aluminium, carpet, rubber and leather



### Scissor - Universal

**Item code: Ts12**

- Universal type
- Steel blade
- Suitable for cutting paper, twine, thin tin can etc

### Scissor - Universal Tullen Type

**Item code: Ts13**

- For cutting of thick material
- For cutting of thin tin material



## Technology

### Screwdriver - Flat



**Item code: Ts14**

- Sizes:
- 3 x 75mm
- 4 x 100mm
- 6 x 150mm

### Screwdriver Set

**Item code: Ts15**

- To fit straight slot screws
- Plastic handle
- Set of 6 (with plastic handles)



### Screwdriver - Star

**Item code: Ts16**

- No. 0 x 60mm
- No. 1 x 75mm

### Screwdriver - Jewellery

**Item code: Ts17**

- Precision type
- Set of 6

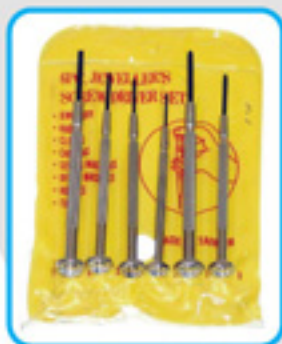



## Technology

### Scriber



**Item code: Ts18**

- Hardened and ground points for accurate marking
- 190mm

### Solar Energy Kit

**Item code: Ts19**

- Educational
- To learn about solar energy and how to build your own solar system
- Complete with solar panel, small motor and propeller blade



### Solder Sucker

**Item code: Ts20**

- A vacuum de-soldering pump
- Designed for one hand operation
- Lightweight and easy to use

### Solder Wire - Resin

**Item code: Ts21**

- 1mm core
- 50gm or 250gm



## Technology

### Soldering Iron



Item code: Ts22

- Electric
- A) 30 Watt
- B) 40 Watt

### Soldering Iron Stand

Item code: Ts23

- To be used with Ts22



### Spanner - Comb

Item code: Ts24

- 7mm
- For use on M4 nuts

### Staple Gun

Item code: Ts25

- Powerful hand tacker for staples
- High compression
- Will work on most hardwood, plywood and plastics



## Technology

### Stapler



**Item code: Ts26**

- Compact
- For general use
- For 26/6 staples

### Staples

**Item code: Ts27**

- For use with staple gun Ts25



### Storage - Mobile Unit

**Item code: Ts28**

- 15 trays
- Lockable
- On castors



### Straw - Drinking

**Item code: Ts29**

- For simple construction work



## Technology

### String - Ball



**Item code: Ts30**

- White string
- 50gm

### Strip & Gusset Pack

**Item code: Ts31**

- 500mm long and 10mm wide
- 45°, 60° and 90° gussets to link the strips and form strong joints
- Containing 40 strips
  - 20 x large, 20 x medium and 20 x small 45°/90°
  - 20 x 60° gussets

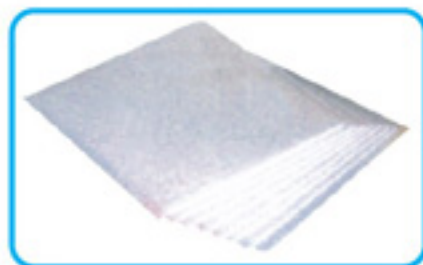

### Styrene Sheet

**Item code: Ts32**

- For use with line bender, vacuum former and general projects
- 610 x 915 x 25mm

### Switch - Mini

**Item code: Ts33**

- A) Push
- B) Mini slide
- C) Mini toggle

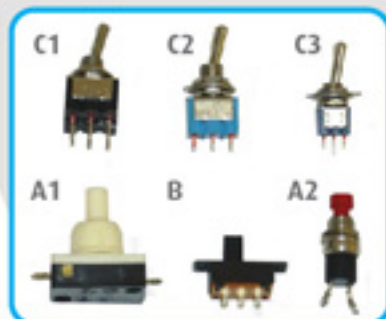

## Technology

### Syringe



#### Item code: Ts34

- Plastic, disposable
- For hydraulics and pneumatics
- Polystyrene barrel and plunger
- Surgical rubber piston, coated with silicone lubricant
- Sizes: 2ml/5ml/10ml/20ml/50ml

### Tape - Dressmaker

#### Item code: Tt1

- 150cm
- In millimetres and centimetres
- Metal tipped on both ends



### Tape - Insulation

#### Item code: Tt2

- Available in different colours

### Tape - Masking

#### Item code: Tt3

- 40m roll x 18mm wide



## Technology

### Tape - Measure



#### Item code: Tt4

- Plastic housing
- Lengths available:
  - 3m x 13mm
  - 5m x 19mm

### Tape - Sello

#### Item code: Tt5

- 50m roll x 12mm wide



### Technology Class Starter Pack

#### Item code: Tt6

- To build projects and explore the basic principles of structures and mechanisms
  - Sufficient items for a class, working in up to 10 groups
- 1) 2 x Strip and gusset packs
  - 2) 2 x Plate packs
  - 3) 5 x Angle bracket packs
  - 4) 1 x Cam pack
  - 5) 1 x Wheel pack 47mm
  - 6) 1 x Wheel pack 67mm
  - 7) 2 x Gear packs
  - 8) 2 x Specialised gear packs
  - 9) 2 x Pulley packs
  - 10) 1 x Cardboard pack
  - 11) 2 x Nut and bolt pack 16mm
  - 12) 2 x Nut and bolt pack 25mm
  - 13) 2 x Wood strip packs
  - 14) 2 x Wood dowel packs 4mm
  - 15) 2 x Right plastic rod packs 4mm

## Technology

### Thermistor



#### Item code: Tt7

- For control circuits
- Resistance changes with heat

### Tin Snip

#### Item code: Tt8

- Can be used instead of scissors
- Cut through thick material
- 200mm long



### Toolkit

#### Item code: Tt9

- Consists of:
  - 1) 1 x Junior hacksaw
  - 2) 1 x Hand drill 6mm chuck
  - 3) 1 x Drill bits 4, 5 and 6mm
  - 4) 1 x Reamer drill 4 - 4.2mm
  - 5) 1 x Scissor, Universal
  - 6) 1 x Utility knife, 8 point snap-off
  - 7) 1 x Safety ruler M-shaped
  - 8) 1 x Try-mitre square, 150mm
  - 9) 1 x Screwdriver, flat, 3 x 60mm
  - 10) 1 x Spanner, no. 7 (M4 nuts)
  - 11) 1 x File set of 3
  - 12) 1 x Table Vice 60mm jaw
  - 13) 1 x Wood glue 125ml
  - 14) 1 x Pliers combination 150mm
  - 15) 1 x Cutting mat 395 x 280 x 10mm
  - 16) 1 x Plastic tray 400 x 290 x 75mm



## Technology

### Toolkit - Class (10 Group)



#### Item code: Tt10

- Contains the tools learners need to work with for the Edutrade Intermediate and Senior Phase Technology Kits
- Sufficient tools for 10 groups of learners
- Supplied in a sturdy plastic trunk for safe storage
- Tools include:
  - 1) Cutting knives
  - 2) Universal scissors
  - 3) Junior hacksaws
  - 4) Bench hooks
  - 5) Hand drills and bits
  - 6) Reamers
  - 7) Pliers
  - 8) Files
  - 9) Screwdrivers
  - 10) Table vices

### Transistor

#### Item code: Tt11

- For electronic projects



### Tray

#### Item code: Tt12

- Ideal for storage of tools, materials and equipment
- Use for group work (tray per group) for easy issue and return of equipment
- Cover available separately
- Sizes available:
  - A) 312 x 427 x 75mm
  - B) 312 x 427 x 150mm
  - C) 312 x 427 x 300mm



## Technology

### Tray - Storage

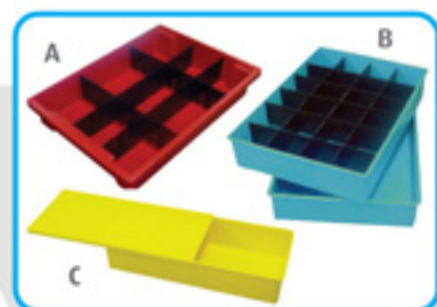

#### Item code: Tt13

- Ideal for storage of tools, materials and equipment
- Use for group work (tray per group) for easy issue and return of equipment
- Sizes available:
  - A) 400 x 290 x 75mm with plastic division strips
  - B) 325 x 235 x 60mm with plastic division strips
  - C) 300 x 125 x 60mm with its own sliding lid

### Tray Divider

#### Item code: Tt14

- To divide tray Tt13 A and B into smaller compartments

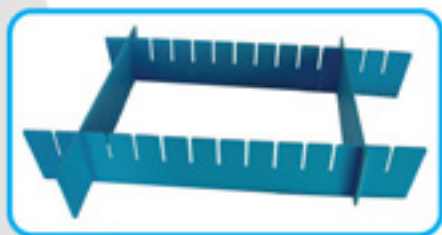

### Tri Square

#### Item code: Tt15

- Metal, 150mm
- Ideal for use with wood strip
- Try mitre for 90° markings

### Tubing

#### Item code: Tt16

- 3mm ID PVC Clear
- For use with plastic t-pieces 3mm ø
- Other sizes available: 6mm/8mm/12mm



## Technology

### Vacuum Former



#### Item code: Tv1

- Designed for moulding ABS and styrene plastic sheets from shapes and forms made by the pupils or from existing moulds
- Low cost version of a normally expensive industrial machine
- Ideal for teaching vacuum forming techniques in materials technology
- Takes 400 x 375mm plastic sheets
- Unit has separate heating and vacuum chambers each with its own operating switch
- Safe and easy to operate
- Rests on any table

### Vice

#### Item code: Tv2

- A) Heavy duty engineers type 100mm  
B) Light duty bench type 60mm jaw



### Wheel Pack

#### Item code: Tw1

- Available in 2 sizes - 47mm and 67mm
- Each pack contains 50 wheels
- Wheels are easily fitted to vehicles and other constructions using 4mm axles and gussets to support the axles

## Technology

### Whetstone



#### Item code: Tw2

- For the sharpening of chisels, knives, etc.
- Coarse and fine sides

### Wire - Binding

#### Item code: Tw3

- Universal purpose
- For binding objects



### Wire - Single Core

#### Item code: Tw4

- Roll of 30m
- A) 0.5mm black insulated
- B) 0.5mm red insulated



### Wire Stripper

#### Item code: Tw5

- Lightweight stripper for electric and electronic applications
- Cuts or strips wire



## Technology

### Wood Strip Pack



#### Item code: Tw6

- A standard 450 x 10 x 10mm size of wood strips supplied in a pack of 50 strips
- Other sizes available
- Ideal as a construction medium
- Easily cut and joined using bolts or it can be glued together with cardboard triangle and wood glue

### Work Top

#### Item code: Tw7

- Consists of 360mm x 360mm board with ruled cm<sup>2</sup> grid surface, 10 clamps and 10 clamping screws
- Clamps grip wood strip tightly in place
- Clamps attach wood strip to board for easy joining and gluing of joints
- Ruled grid lines ideal for lining up strips for accurate joining
- Accessories: Work Top Clamp Pack - used to clamp onto Work Top
- Particularly good for making wood strip frames
- Helps raise the quality of pupils' work and introduces good practice and safety techniques

